

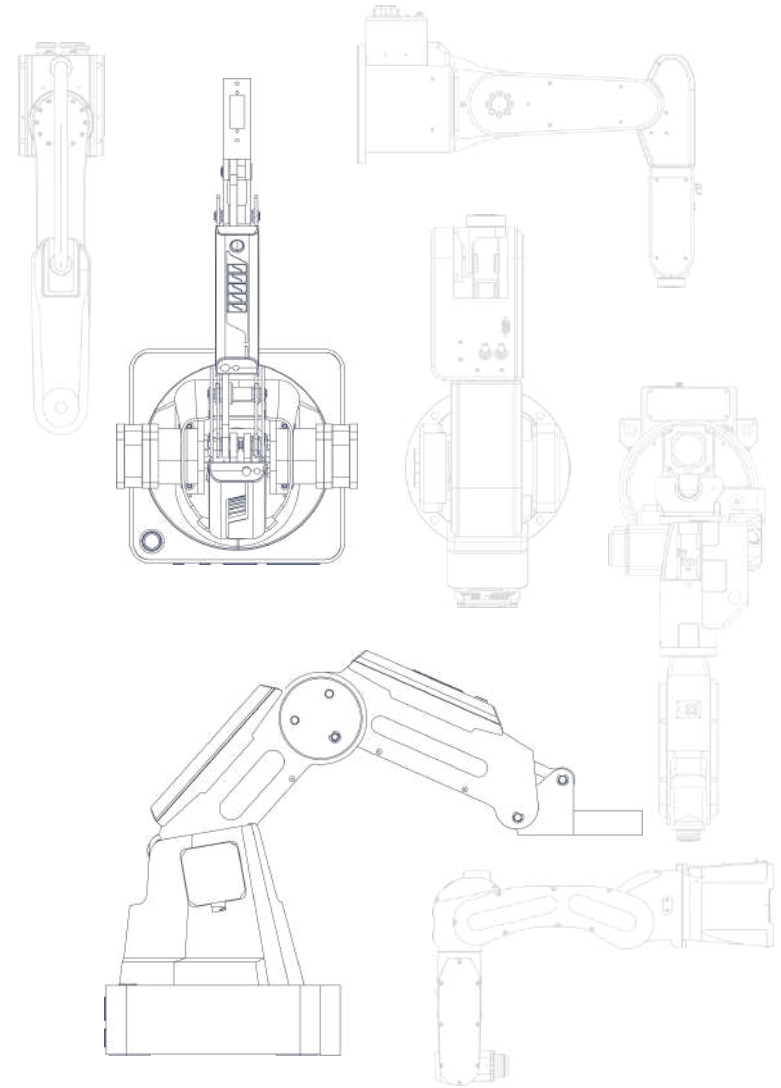

DOBOT Education Project Cases



Campus Digitalisierung Volkswagen Akademie Hannover

- Cooperative project with German Volkswagen-DOBOT Magician adapts to Siemens PLC system, which is used by German Volkswagen for its teaching production line
- Products: Magician: 20 Set





Escuela De Ingenieria Y Design Industry University In Spain

- Product: Magician 10set
- Currently, the major courses are only offered for junior students with a total of 75 lessons in university.
- Combined with ARDUINO and MATLAB, Magician was applied in electronica digital instrumentation electronic courses.





Universidad de Castilla - La Mancha In Toledo ,Span

- Product: Magician :
4 Set
- Combined with
ARDUINO ,MATLAB
and PYTHON,
Magician was
applied in
mechatronics



POLYTECH UNIVERSITY IN PARIS

- Product :
Magician
- Applied to User
ROS and Visual
Sorting

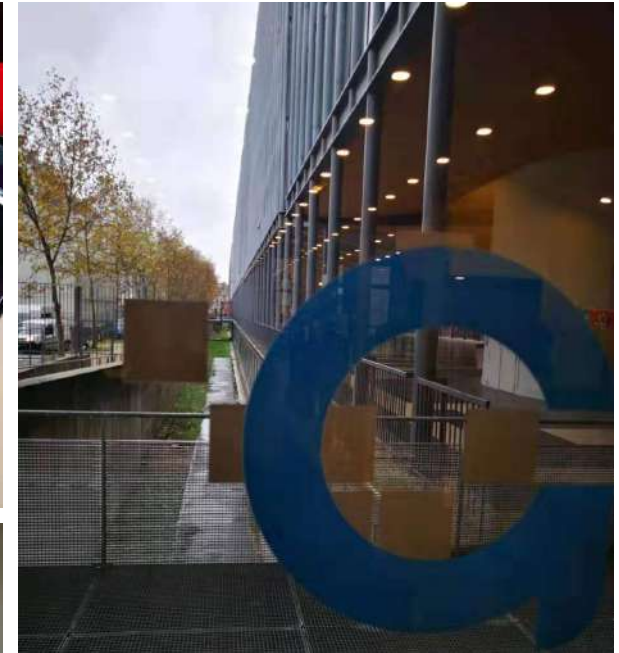
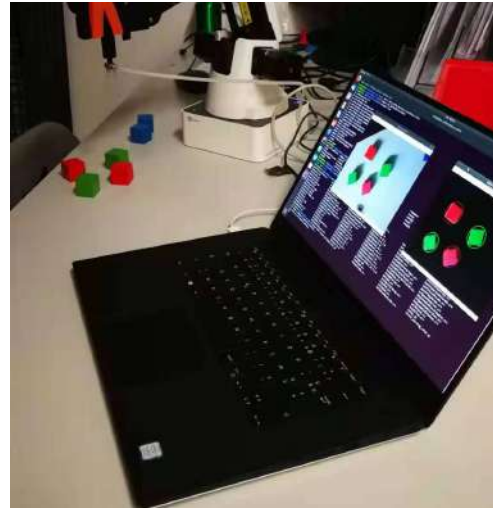



Oxford University AI Lab



- Product: : Dobot Magician + Conveyor Belt Kit
- Application : AI Lab
- User Cases:
 1. Control the Dobot using voice. (NLP)
 2. Use image processing to control the movement of Dobot (CNN).



Häme University In Finland



- Senior student of Hame University, used for programming learning and secondary development research to improve students' hands-on ability

- Product :
Magician (Educational):10 Set
Conveyor: 2 Set
Linear Rail Kit: 2 Set



University of California In USA

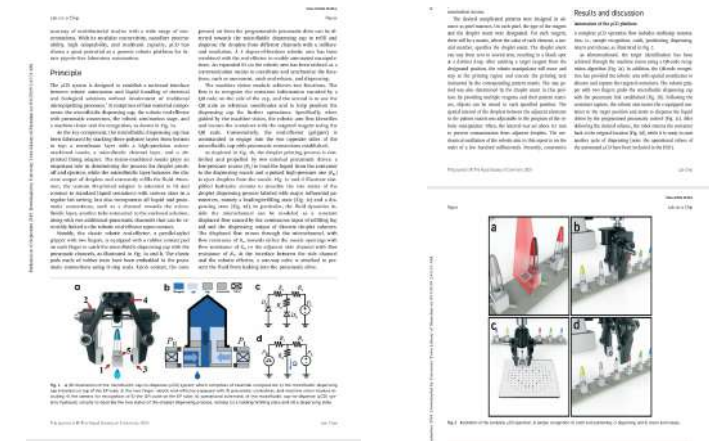
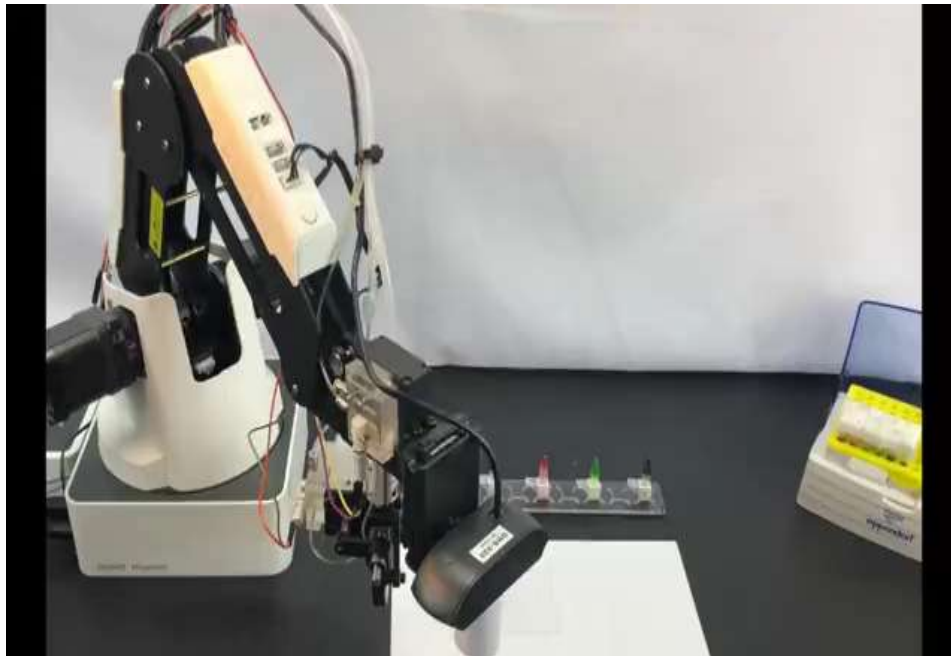

- Applied to the university of California, Davis, a laboratory, used in biomedical laboratories
- Products : Magician



The University of Technology Sydney In Australia

- Application major: Robotics, Introduction to Industrial Robotics and Underlying Algorithms Mathematics
- Students build their own simulated industrial robot by modelling the robot arm and then writing control and planning software so that it can perform motion tasks.
- Product: Dobot Magician: 20 Set

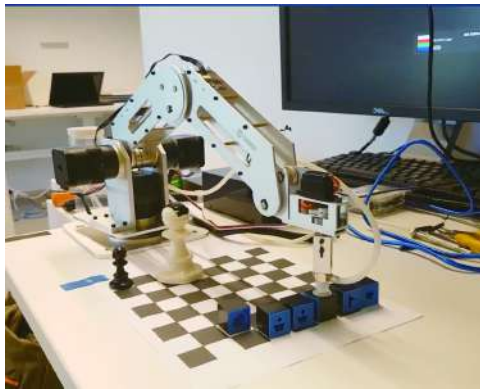



Bucheon University In Korea

- Magician was used for teaching programming
- Products :Magician



Sookmyung Womens University In Korea

- Applied to curriculum concepts and trends
- Product: Magician 6 Set



Osaka Prefecture University In Japan

- Osaka prefectural university, Japan, joined hands with Yuejiang technology to introduce Yuejiang DOBOT desktop modular robot , M1 cooperative robot and its accessories for teachers and students to conduct teaching and research, creating a professional learning platform for students to learn robot technology and its application. The research contents mainly include:
 1. Handling of soft objects;
 2. Grab and move the paper cup without breaking it;
 3. Move and move eggs without breaking hard-boiled eggs;
 4. Transfer the pasta like rope by set weight
- Product : Dobot M1 4set

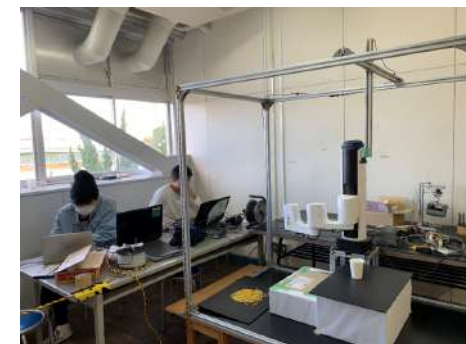



King Mongkut's Institute of Technology Ladkrabang In Thailand

- It is applied to Robotics, PLC, Automation, Labview and other robot teaching in College of Advanced Manufacturing Innovation

- Product :
Dobot magician : 20 Set
M1 : 14 Set





**Nakornratchasima Technical
College In Thailand**

- Applied to Mechatronic Department course
- Product :
Dobot Magician : 10
Conveyer : 1
Linear : 1
M1 and table : 1
Computer (table and chair) : 10



Private Hsinchu Senior Industrial Vocational School In Taiwan

- Applied to teach Robotics and Mechatronics
- 15pcs of Dobot Magician

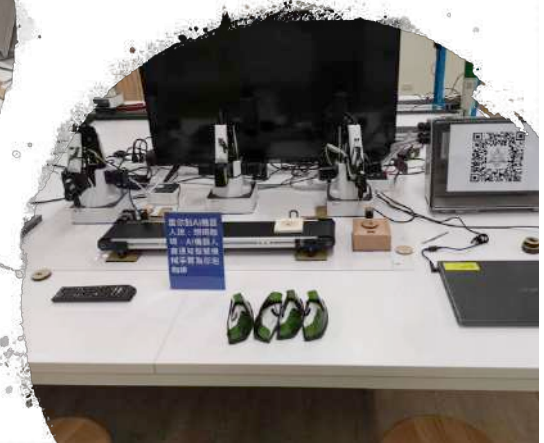
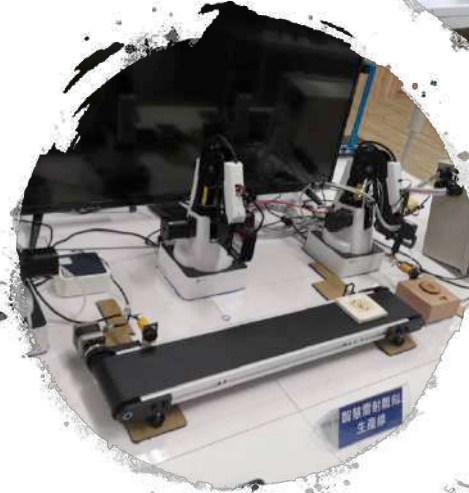

National United University In Taiwan

- Teachers and Students use Dobot M1 for research, machine vision and industrial applications

- Product: Dobot M1

